

City of Boise
ADA Assessment



Lowell Pool

11/20/2020

Report #TO20-B004

Prepared by:



Table of Contents

- 1.1 Introduction and Location Overview 3
 - 1.1 Introduction 3
 - 1.2 Location Overview..... 4
- 2.0 Deficiencies and Solutions..... 5
 - 2.1 Assessment Process 5
 - 2.2 Human Centered Design 5
 - 2.3 General 6
 - 2.4 Parking..... 7
 - 2.5 Accessible Routes..... 8
 - 2.5.1 Protruding Objects..... 9
 - 2.5.2 Ramps 10
 - 2.5.3 Stairways 10
 - 2.5.4 Handrails 11
 - 2.5.5 Doors and Doorways..... 12
 - 2.6 Amenities..... 13
 - 2.6.1 Reach Range..... 13
 - 2.6.2 Drinking Fountains..... 15
 - 2.7 Service Counters 16
 - 2.8 Dining and Work Surfaces..... 18
 - 2.9 Restrooms and Locker Rooms..... 19
 - 2.9.1 Toilet Compartments..... 19
 - 2.9.2 Urinals..... 20
 - 2.9.3 Toilet Paper Dispenser 21
 - 2.9.4 Grab Bars 22
 - 2.9.5 Sink, Mirror, and Shelf..... 23
 - 2.9.6 Locker Room Showers 24
 - 2.10 Room Signage 25
- 3.0 Prioritization..... 26
- 4.0 Implementation and Financial Plan..... 27
 - 4.1 Development of Costs 27
 - 4.2 Implementation Plan 28

List of Figures

Figure 1.1 Lowell Pool (Source: Pinterest)	4
Figure 1.2 Aerial Photo of Lowell Pool (Source: Google Maps)	4
Figure 2.1 Accessible Parking Spaces.....	8
Figure 2.2 Accessible Route Standards Diagram	9
Figure 2.3 Protruding Objects.....	9
Figure 2.4 Stair Nosings	11
Figure 2.5 Handrails	11
Figure 2.6 Accessible Maneuvering Clearance at Doorway	12
Figure 2.7 Accessible Garbage Can Located Adjacent to Paved Trail	13
Figure 2.8 Unobstructed Reach Range.....	14
Figure 2.9 Obstructed Reach Range	15
Figure 2.10 Side Obstructed Reach Range	15
Figure 2.11 Drinking Fountain Location.....	16
Figure 2.12 Drinking Fountain Height.....	16
Figure 2.13 Parallel Approach Service Counter	17
Figure 2.14 Forward Approach Service Counter	17
Figure 2.15 Accessible Dining and Work Surface	18
Figure 2.16 Toilet Location	20
Figure 2.17 Urinal Height and Depth	20
Figure 2.18 Toilet Paper Dispenser.....	21
Figure 2.19 Grab Bars.....	22
Figure 2.20 Bathroom Sinks and Mirror.....	23
Figure 2.21 Locker Room Showers	24
Figure 2.22 Room Signage	25

List of Tables

Table 2.1 Accessibility Violation Summary	6
Table 2.2 Minimum Accessible Parking Requirements.....	7
Table 3.1 Prioritization Designations	26
Table 4.1 Cost Summary	27

1.1 Introduction and Location Overview

1.1 Introduction

The Americans with Disabilities Act (ADA) of 1990 is a civil rights statute that prohibits discrimination against people with disabilities. The ADA states that by designing and constructing facilities for public use that are not accessible to people with disabilities could constitute discrimination. The ADA applies to all facilities, including those built before and after 1990, and local governments are required to perform a self-evaluation of their infrastructure and identify all barriers to accessibility. An ADA Transition Plan shall then be developed to address all ADA related deficiencies.

The ADA Transition Plan is intended to achieve the following:

- Identify physical barriers that limit the accessibility of the facility to individuals with disabilities,
- Describe the methods to be used to make the facility accessible
- Provide a schedule for removing the barriers to accessibility, and
- Identify the name of the official responsible for the plan's implementation.

In an effort to improve access, safety, and accessibility of citizens with disabilities, the City of Boise is conducting an ADA Assessment and developing an ADA Transition Plan for Forty-Two (42) City Owned buildings. To ensure that City facilities are accessible for persons with disabilities, Tindale Oliver's review covers facility entrances and exits, accessible routes, curb ramps, handrails, existing indoor and outdoor facilities, doors, restrooms, signage, as well as other amenities.

This assessment includes a comprehensive inventory of the conditions of the City facilities and identifies and prioritizes improvements to address deficiencies. Information relating to the accessibility of each facility has been collected. The purpose of these data is to improve City staff understanding of accessibility issues pertaining to the ADA, Idaho Building Code requirements, and the International Building Code (IBC)—specifically, how the ADA and the Idaho Building Code relate to individual facilities and how to identify elements and facilities that are in compliance with the ADA and those that are not. This document serves as the ADA Transition Plan's summary report outlining the development of the facility inventory and database of the barriers to accessibility and the prioritization/phasing plan of the improvements. A separate appendix document has been prepared that includes a detailed summary of each violation and recommendation.

1.2 Location Overview

Lowell Pool is located at 1601 N 28th Street, northwest of downtown Boise. Lowell Pool is a public facility built in 1953 for Boise youth and adult residents, that offers swim lessons, seasonal passes, and competitive swim teams. The pool is directly adjacent to the Lowell Elementary School and a half-mile from Elm Grove Park.



Figure 1.1 Lowell Pool (Source: Pinterest)

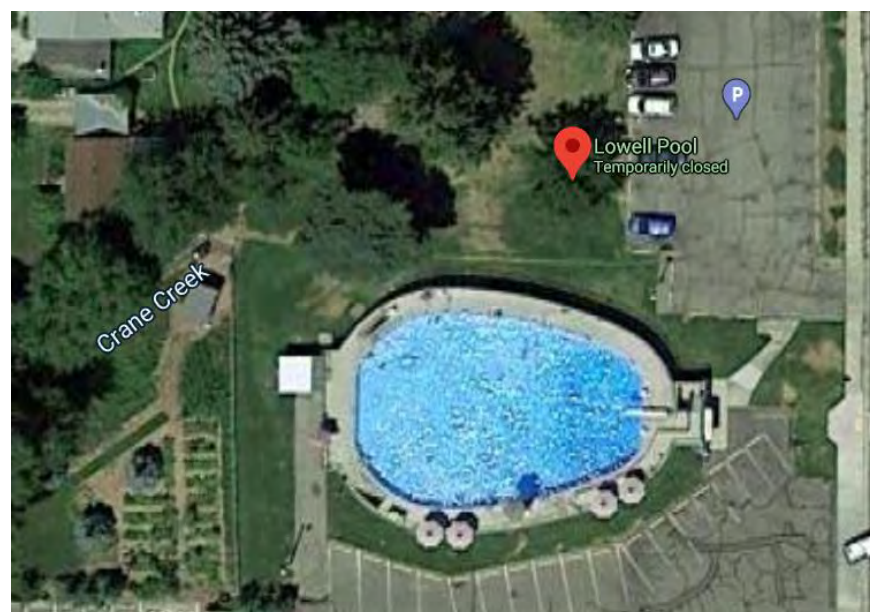

Figure 1.2 Aerial Photo of Lowell Pool (Source: Google Maps)

2.0 Deficiencies and Solutions

2.1 Assessment Process

A walk-thru and assessment of building elements for compliance with applicable accessibility standards was conducted on September 18, 2020, by Tindale Oliver staff certified as Accessibility Inspectors.

The facility survey addressed each accessible element and space within and external to the facility and included applicable elements such as facility entrances/exits, parking, sidewalks, accessible routes, curb ramps, handrails, signage, existing indoor and outdoor facilities, doors, restrooms, and all other elements covered by the Americans with Disabilities Act Accessibility Guidelines (ADAAG) and the IBC.

The survey included physical measurements and counts for components or systems. Survey findings were collected and recorded on Tindale Oliver's custom Android-based ADA compliance checklist application. Photos were taken with the tablet of each area of the facility for familiarization and were later referenced to illustrate deficiency findings. A smart-level measuring wheel and a tape measure were used to evaluate physical features.

The digital data and photos were then uploaded to a database on Tindale Oliver's secure servers for backup. Where appropriate, photos are included in this Accessibility Assessment Report (AAR), as shown in Appendix A, to illustrate issues or deficiencies. The facility survey consisted of non-intrusive visual observations, which allowed for a readily-accessible and easily-visible components and systems assessment of the facility, which included measurements of space and clearance dimensions, slope, walkway widths, reach ranges, maneuverability measurements, etc.

2.2 Human Centered Design

After identifying barriers to accessibility and laying out solutions as required by the ADA, our team will recommend a holistic solution. Human Centered Design offers solutions that do not focus solely on the barrier, but also on the needs, contexts, and behaviors of the users that the solutions will serve. It is a process that turns difficult challenges into desirable outcomes for individuals of all abilities. This process involves identifying solutions with the end user, through engagement with the Boise's ADA community. The result is a set of recommendations that are data-driven and personalized to fit the needs of the community.

- **Human Centric:** human centered design solutions involve creating solutions that focus on the needs of the community. This is achieved through public outreach and getting to really understand the challenges faced by a person with disabilities in Boise. This design process prioritizes the following:
 - Equitable use
 - Flexibility
 - Low physical effort

- Simple, intuitive design
- **Understanding behaviors, thoughts and emotions:** this involves understanding Boise residents’ perception when it comes to accessibility. Even though behaviors, thoughts and emotions are not quantifiable, they are usually critical in understanding the root of the issue and from that, our team can provide solutions that will be embraced by the community.
- Think of accessibility as a system.

2.3 General

The use and occupancy of the Lowell Pool dictates egress and accessible route requirements consistent with ADAAG regulations. Because the general public regularly accesses the facility, and in the interest of establishing an accessibility compliance baseline condition report of the facility, a full accessibility assessment was conducted. Where deficiencies in compliance with ADAAG or IBC exist, descriptions of the deficiency, regulatory requirement(s) pertinent to the deficiency, a photo showing the deficient element, and recommendations for remediation of the deficiency are shown in Appendix A.

The following sections generally describe and illustrate common barriers to accessibility found throughout the building.

Table 2.1 Accessibility Violation Summary

ACCESSIBILITY VIOLATION	2010 ADA Standards for Accessible Design
Category	
Signage	§216.2 and §703
Restrooms	§307, §308, §604, §605, and §609
Protruding Objects	§211.2, §307, and §602.7
Amenities (shelves, hooks, benches, etc.)	§307, §308, §405, §707, and §903
Parking (slopes, access aisle, parking signs)	§206.2, §208.2, and §502
Accessible Path	§303, §305, §307, §403, and §404
Counters	§306, §902, and §904
Showers	§213.3.6, §404, §607, §609, and §610
Drinking Fountains	§211.2 and §602.7
Doorways	§309.4 and §404.2.4
Handrails	§505.2 and §505.10

2.4 Parking

Accessible parking is vital in allowing visitors access to the facility. Parking spaces are not required by the ADA. Nonetheless, if parking is provided, accessible parking also must be provided and must meet the following requirements and guidelines as outlined in the ADA.

Standards:

- Accessible car parking spaces shall be at least 96” wide.
- Accessible van parking spaces shall be at least 132” wide.
 - Van parking spaces can be 96” wide where the access aisle 96” wide.
- Accessible parking spaces shall have an adjacent access aisle that is 60” wide minimum.
- The access aisle shall connect to an accessible route.
- Accessible parking spaces and access aisles shall have a running slope and a cross slope no greater than 2%.
- The accessible parking and access aisle shall be made from a surface that is firm, stable, and slip resistant (wet or dry).
- Accessible parking spaces shall have signs identifying them.
 - Signs identifying van parking spaces must include the phrase “van-accessible.”
 - Signs must be at least 60” above the ground.
 - The signage shall include the International Symbol of Accessibility.
- At least one space for every 6 or fraction of 6 accessible spaces must be van accessible.
- Accessible parking spaces, aisles, and routes should be maintained in good repair and marked clearly. Spaces must not be used for snow, ice, or fallen leaf removal.
- Vertical clearance of 98” must be provided to parking spaces.
- The minimum number of accessible parking spaces are based upon the total number of parking spaces, as summarized in Table 2.2.

Table 2.2 Minimum Accessible Parking Requirements

Total Parking Spaces	Minimum Accessible Parking
1-25	1
26-50	2
51-75	3
76-100	4

Figure 2.1 illustrates the standards mentioned above.

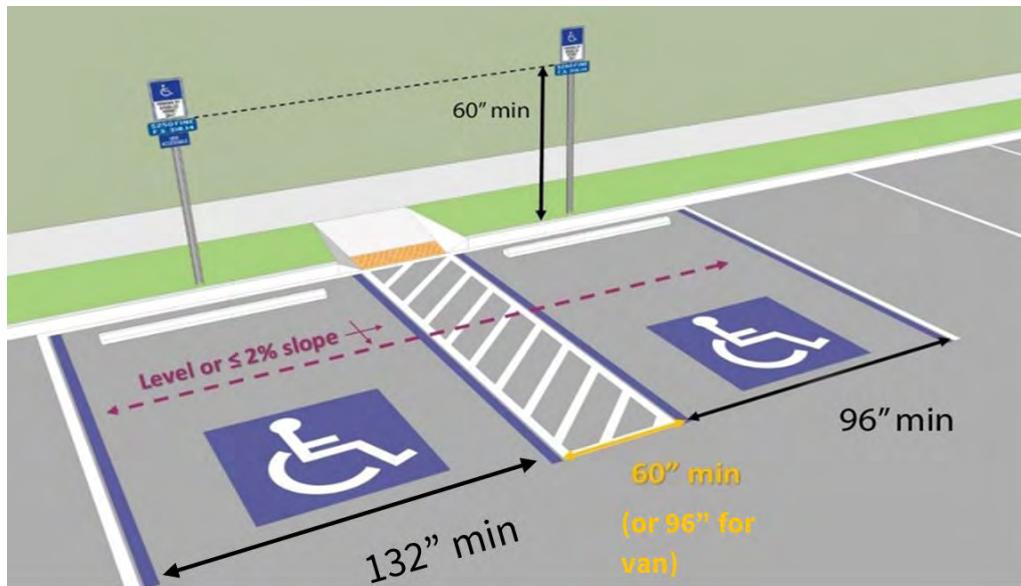

Figure 2.1 Accessible Parking Spaces

2.5 Accessible Routes

Sidewalks and routes that connect to the pedestrian arrival points must be accessible. In addition, the requirements listed below also apply to all internal accessible routes used by the public as they navigate the internal corridors of the building, as described in sections §301 and §401 of the 2010 ADA Standards for Accessible Design.

Standards:

- The surface must be firm, stable, and slip resistant (wet or dry).
- Shall be a 36" minimum wide continuous unobstructed path.
 - The accessible route is allowed to decrease to a width of 32" for a maximum distance of 24", as shown in Figure 2.2.
- Shall have 60"x60" passing spaces at 200' intervals minimum.
- The running slope (parallel to direction of travel) must be equal to or less than 5% (>5% = ramp) for an accessible route. However, a sidewalk is permitted to have a running slope greater than 5% if it follows the slope of the adjacent roadway.
- The cross slope (perpendicular to direction of travel) must be less than or equal to 2%.
- Changes in level between 1/4" and 1/2" must be beveled at 1:2 slope.
- Changes in level greater than 1/2" are not allowed or must be ramped.
- Gaps in gratings must be no greater than 1/2" wide and openings must be aligned perpendicular to travel.

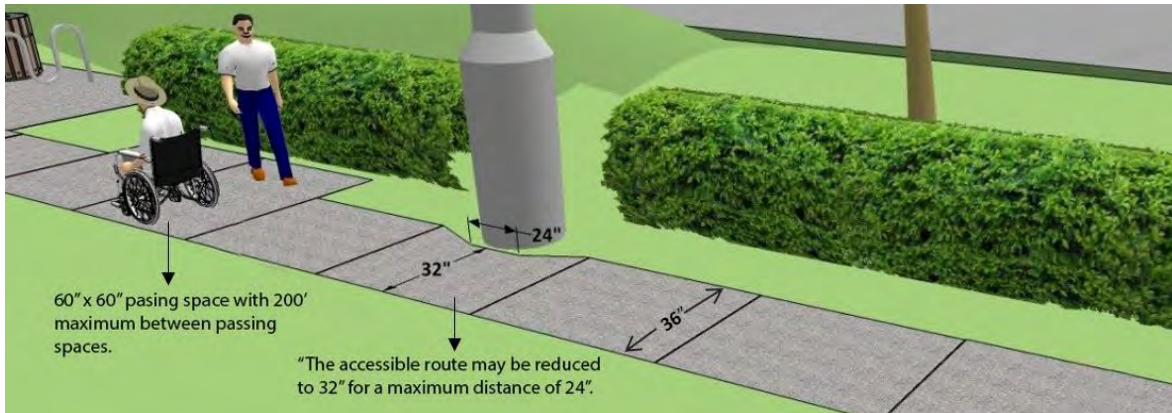

Figure 2.2 Accessible Route Standards Diagram

2.5.1 Protruding Objects

Protruding objects shall comply with §307 of the 2010 ADA Standards for Accessible Design.

Standards:

- Objects with edges between 27” and 80” above the floor can be considered protruding objects, as shown in
- Figure 2.3, if their edges protrude more than 4” horizontally into the circulation path.
- Handrails are permitted to protrude 4 ½” maximum.

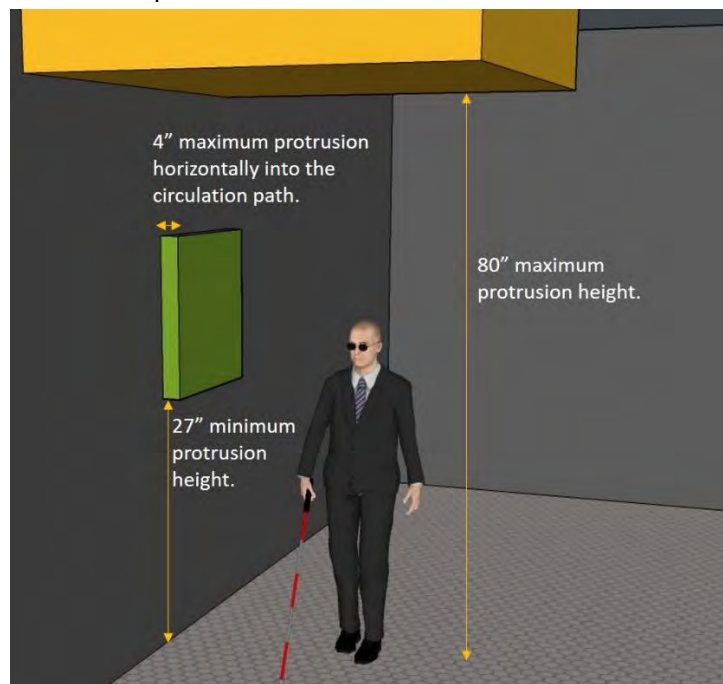

Figure 2.3 Protruding Objects

2.5.2 Ramps

The requirements for a ramp are more stringent than those of an accessible route, as listed in §405 of the 2010 ADA Standards for Accessible Design and described below.

Standards:

- Shall have a minimum of a 36” wide continuous unobstructed path.
- The running slope (parallel to direction of travel) must not be steeper than 8.3%.
- The cross slope (perpendicular to direction of travel) must be 2% or less.
- The rise shall be 30” maximum.
- Landings must be located at the top and bottom of all ramp runs and must be a minimum of 60” long and at least the width of the ramp.
 - Ramps that do not have level landings at changes in direction can create a compound slope. Curvilinear ramps continually change direction and cannot, by their nature, meet the requirements for accessible routes.
- Ramp runs with a rise greater than 6” shall have handrails and edge protection.

2.5.3 Stairways

Stairs are part of the accessible route and shall comply with §504 of the 2010 ADA Standards for Accessible Design.

Standards:

- All steps on a flight of stairs shall have uniform risers and tread depth.
- Risers shall have a minimum height of 4” and 7” maximum.
- Tread depths shall be 11” minimum.
- It is recommended to provide visual contrast on tread nosings, or at the leading edges of treads without nosings, so that treads can be more visible to people with low vision.
- The radius of curvature at the leading edge of the tread shall be ½” maximum. Nosings that project beyond risers shall have the underside of the leading edge curved or beveled. Risers shall be permitted to slope under the tread at an angle of 30 degrees maximum from vertical. The permitted projection of the nosing shall extend 1½” maximum over the tread below.
- Stairs that are subject to wet conditions shall be designed to prevent the accumulation of water.

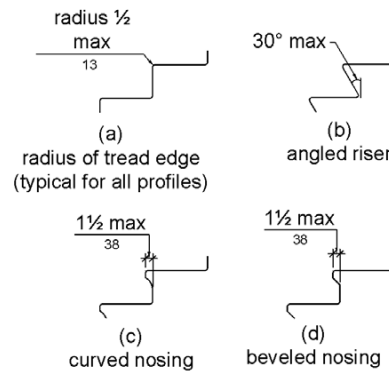

Figure 2.4 Stair Nosings

2.5.4 Handrails

Handrails along ramps and stairs shall comply with §405.8 and §505 of the 2010 ADA Standards for Accessible Design.

Standards:

- Handrails must be provided along ramps and stairs. Where handrails are required, they must be installed on both sides of the ramp or stairs.
- Handrail gripping surfaces shall be installed at a height of 34” minimum and 38” maximum above the walking surface, stair nosing, and ramp surface.
- The clearance between handrail and adjacent surface shall be 1 ½” minimum.
- Ramp handrails shall extend 12” minimum beyond the top and bottom of ramp runs. Extensions shall be continuous and return to a wall or be continuous to the handrail of an adjacent ramp run.
- At the top of the stairs, handrails shall extend horizontally 12” minimum directly above the stair riser and shall return to the wall or guard, as shown in Figure 2.5.
- At the bottom of the stairs, handrails shall extend a distance at least equal to one tread depth beyond the last riser and return to the wall or guard, as shown in Figure 2.5.

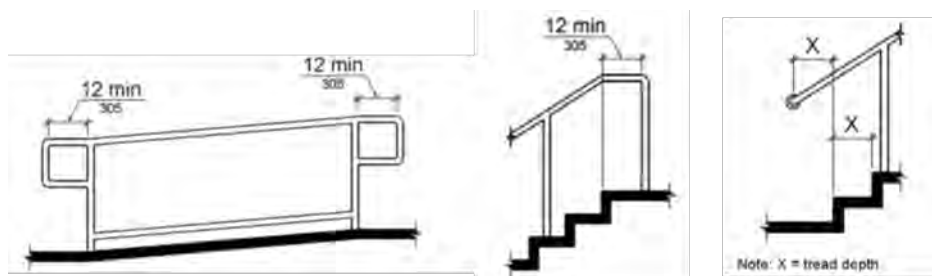

Figure 2.5 Handrails

2.5.5 Doors and Doorways

Doors and doorways that are part of accessible routes and shall comply with §404 of the 2010 ADA Standards for Accessible Design.

Standards:

- Sixty percent (60%) of all public entrances shall be accessible. Directional signs shall be provided to guide users to the nearest accessible means of egress.
- Accessible doors shall have a clear width of 32” minimum measured between the face of the door and the stop.
- If thresholds are provided, they shall be ½” high maximum.
- The distance between two doors in series shall be 48” minimum plus the width of the door swinging into the space.
- The maneuvering clearance varies depending on type of door and direction of approach. The most commonly used door with a front approach, requiring the user to pull to it, shall have a 60” maneuvering clearance perpendicular to doorway and 18” parallel to doorway, as shown in Figure 2.6.
- Operable parts such as door handles, pulls, latches and locks shall be located 34” minimum and 48” maximum above the floor.
- The door closing speed from a 90-degree open position to 12 degrees shall be 5 seconds minimum.

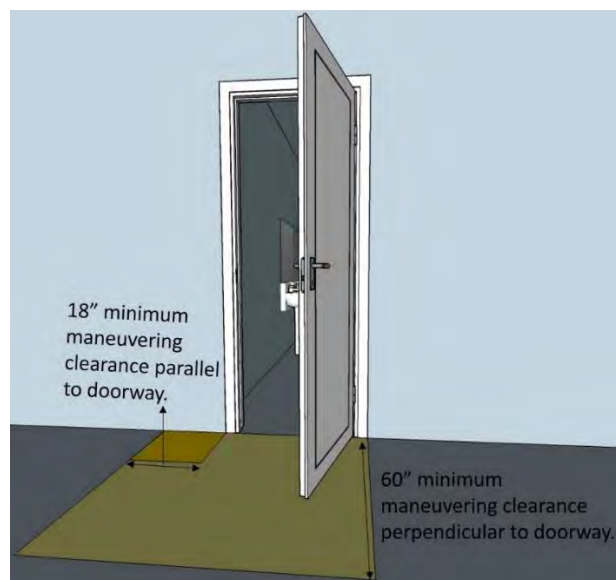

Figure 2.6 Accessible Maneuvering Clearance at Doorway

2.6 Amenities

2.6.1 Reach Range

Care should always be taken when designing or improving an accessible route within a building to keep the path free of obstructions. Amenities such as benches, garbage cans, and drinking fountains must be placed to not interfere with the accessible path but, at the same time, must be located on an accessible route, within reach range, and not act as a protruding object. Not only can these obstructions prevent visitors from accessing and using the amenities, they can also present a potential safety concern.

It should be stressed that amenities that are located off the accessible path are considered inaccessible. For items to be accessible, they must be located on, adjacent to, or within reach of a firm, stable, and slip-resistant surface, as shown in Figure 2.7.



Figure 2.7 Accessible Garbage Can Located Adjacent to Paved Trail

To help clear existing accessible paths from obstructions and to identify those features that are currently inaccessible, data on infrastructure were collected in the field to determine if they present an obstruction or are inaccessible. Based on the data collected, the difficulty level of remediating a barrier to accessibility could range from moving a bench to an accessible location to designing and installing a new accessible route to an amenity.

Reach range standards, as described below and shown in §308 of the 2010 ADA Standards for Accessible Design, were used to determine if an amenity can be accessed by a person in a wheelchair.

Standards:

- A level, 30”x48”, firm, stable, and slip-resistant clear floor space must be present adjacent to the amenity.
- Forward Approach:
 - The unobstructed minimum vertical reach range is 15” and maximum is 48” above the floor, as shown in **Error! Reference source not found.8.**
 - The obstructed reach range is 48” maximum above the floor if the horizontal obstruction depth is 20” maximum, and 44” maximum if the horizontal depth is between 20”-25”, as shown in **Error! Reference source not found.9.**
- Side Approach:
 - The unobstructed side reach range is 15” minimum and 48” maximum above the floor. These same dimensions are permitted where an obstruction depth is 10” maximum, as shown in **Error! Reference source not found.10.**
 - Where the side reach is over an obstruction, the height of the obstruction is 34” maximum and the depth of the obstruction shall be 24” maximum. The high side reach shall be 48” maximum for a reach depth of 10” maximum. Where the reach depth exceeds 10”, the high side reach shall be 46” maximum for a reach depth of 24” maximum.

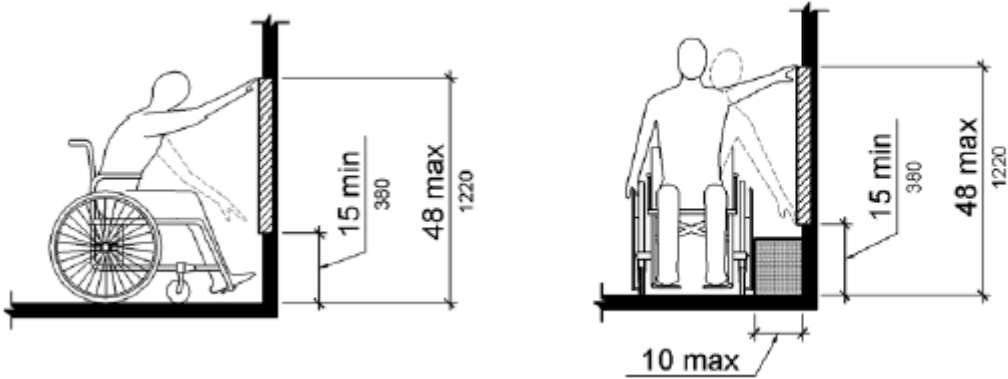

Figure 2.8 Unobstructed Reach Range

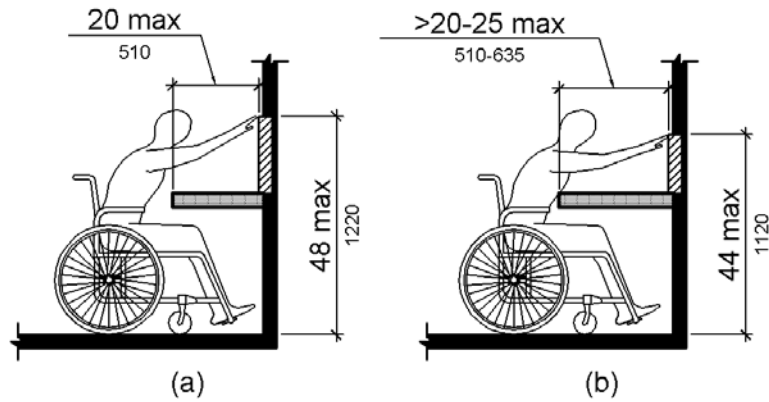

Figure 2.9 Obstructed Reach Range

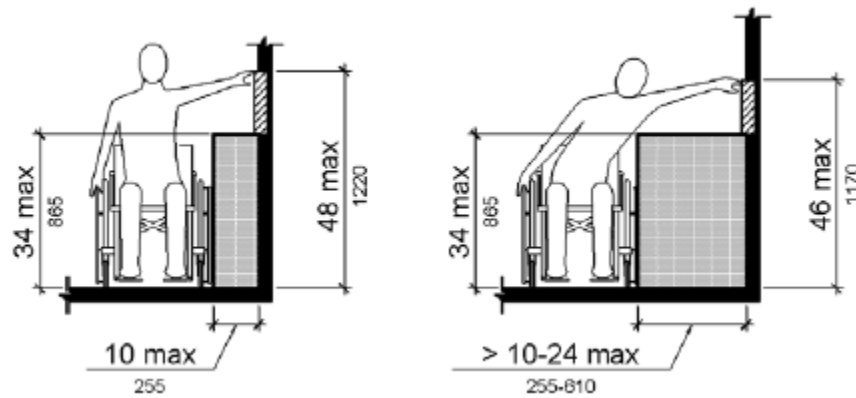

Figure 2.10 Side Obstructed Reach Range

2.6.2 Drinking Fountains

Drinking fountains, like all amenities, must be accessible, as described in §602 of the 2010 ADA Standards for Accessible Design.

Standards:

- Drinking fountains shall be connected to an accessible route.
- The clear floor space, positioned for a forward approach, adjacent to the drinking fountain shall:
 - Be a minimum of 30”x48” in size.
 - Not have any slope greater than 2%.
 - Have a firm, stable, and slip resistant surface.
- Where drinking fountains are provided, there shall be at least two.
 - For a low fountain, the waterspout height shall be 36” maximum above the floor.
 - For standing persons, the waterspout height shall be 38” minimum and 43” maximum above the floor.

- The spout shall provide a flow of water 4” high minimum and shall be located 5” maximum from the front of the unit.

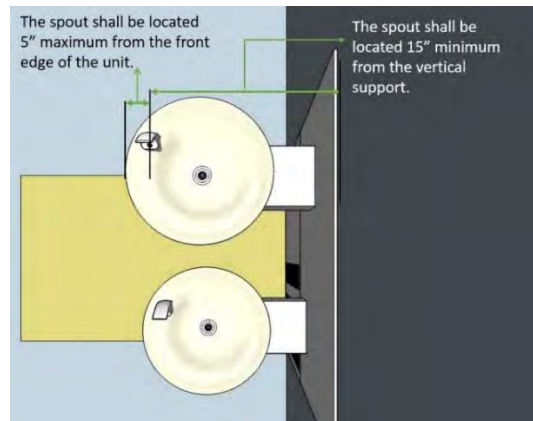

Figure 2.11 Drinking Fountain Location

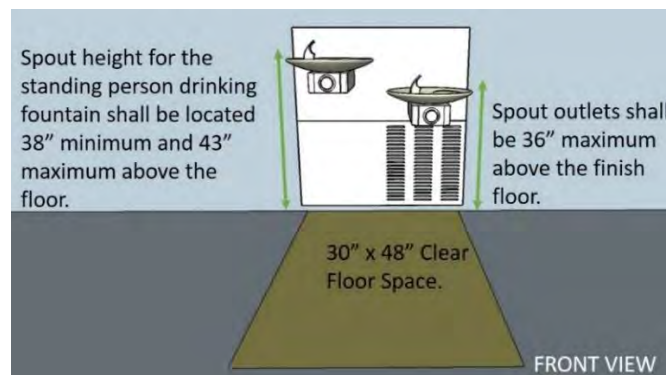

Figure 2.12 Drinking Fountain Height

2.7 Service Counters

Service and sales counters, like all amenities, must be accessible, as described in §904.4 of the 2010 ADA Standards for Accessible Design.

Standards:

- The accessible portion of the countertop shall extend the same depth as the sales or service countertop.
- For a parallel approach, a portion of the counter surface that is 36” long minimum and 36” high maximum above the finish floor shall be provided.
 - A clear floor or ground space complying with §305 shall be positioned for a parallel approach adjacent to the 36” minimum length of counter.
- For a forward approach, a portion of the counter surface that is 30” long minimum and 36” high maximum shall be provided.
 - Knee and toe clearance shall be provided under the counter.

- Toe clearance shall extend a minimum of 17” to a maximum of 25” under the counter.
 - The clearance under the element shall be 9”.
- Knee clearance shall extend a minimum of 11” to a maximum of 25” under an element at 9” above the floor.
- A clear floor or ground space complying with §305 shall be positioned for a forward approach to the counter.

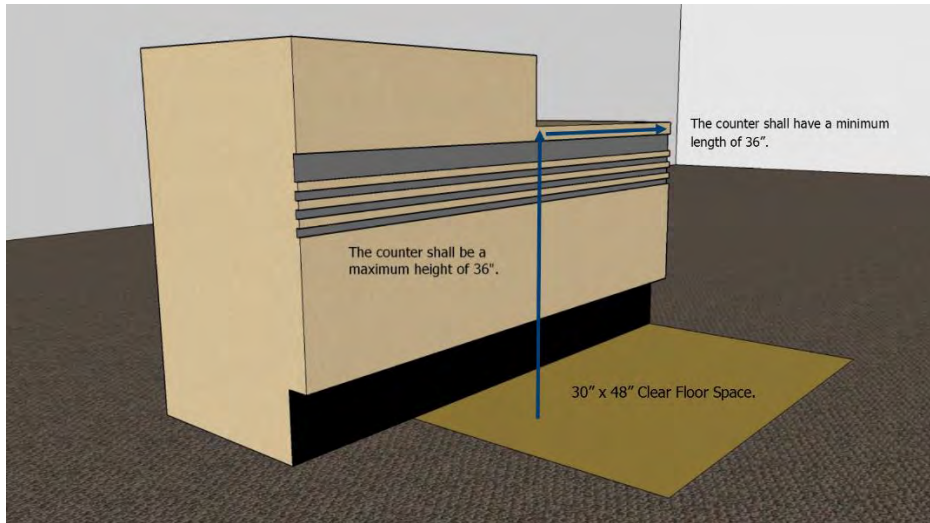

Figure 2.13 Parallel Approach Service Counter

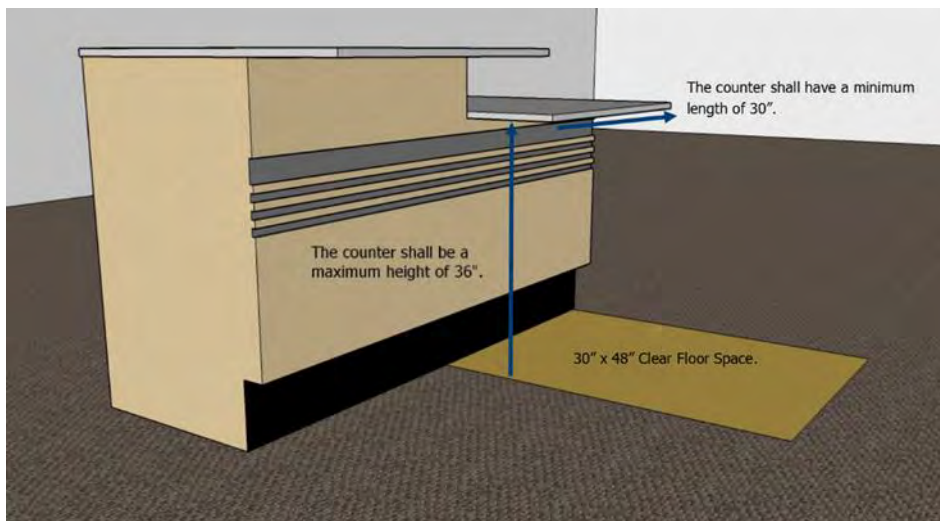

Figure 2.14 Forward Approach Service Counter

2.8 Dining and Work Surfaces

Dining and work surfaces must be accessible as described in §902 of the 2010 ADA Standards for Accessible Design.

Standards:

- Clear floor space complying with §305 positioned for a forward approach shall be provided.
- The tops of dining surfaces and work surfaces shall be 28" minimum and 34" maximum above the finish floor or ground.
- Accessible dining surfaces and work surfaces for children's use shall comply with §902.4.



Figure 2.15 Accessible Dining and Work Surface

2.9 Restrooms and Locker Rooms

Due to the historic nature of the Lowell Pool facility, it is recommended that the City construct accessible Men's and Women's locker rooms adjacent to the pool with access from the pool deck via an elevator. Each locker room shall have an accessible stall with grab bars, an accessible shower, and lockers. The current configuration of the restrooms does not allow for the toilet compartments to be expanded to meet accessible toilet compartment requirements under §604.

Accessible toilet compartments shall contain a compliant toilet, side, rear, and vertical grab bars, a toilet paper dispenser, and have a self-closing door. The compartment shall be a minimum of 56" by 60". Accessible shower stalls shall be either a transfer type, standard roll-in type, or alternate roll-in type shower compliant with §608.2. Each shower shall contain a shower seat and compliant controls and spray units.

2.9.1 Toilet Compartments

Restrooms are not required by the ADA. However, if provided, then accessible restrooms must also be available per §604 of the 2010 ADA Standards for Accessible Design.

Standards:

- Toilet compartment:
 - The toilet compartment shall be 56" minimum measured from the back wall and 60" minimum measured from the side wall for wall hung water closets.
 - The toilet shall be located 16" minimum to 18" maximum from the sidewall for wheelchair accessible stalls, as shown in Figure 2.16.
 - Seat heights shall be 17" minimum to 19" maximum above the floor.
 - A 60" wide turning space shall be provided within the room. Turning space, clear floor space, and clearance at fixtures shall be permitted to overlap. Doors shall be permitted to swing into the turning space but shall not swing into the clear floor space or clearance at fixtures.
 - Flush controls shall be hand-operated or automatic. Flush controls shall be located on the open side of the toilet.
- Urinals shall be installed at a maximum height of 17" above the floor and a minimum depth of 13 ½" measured from the outer surface of the urinal to the back wall.

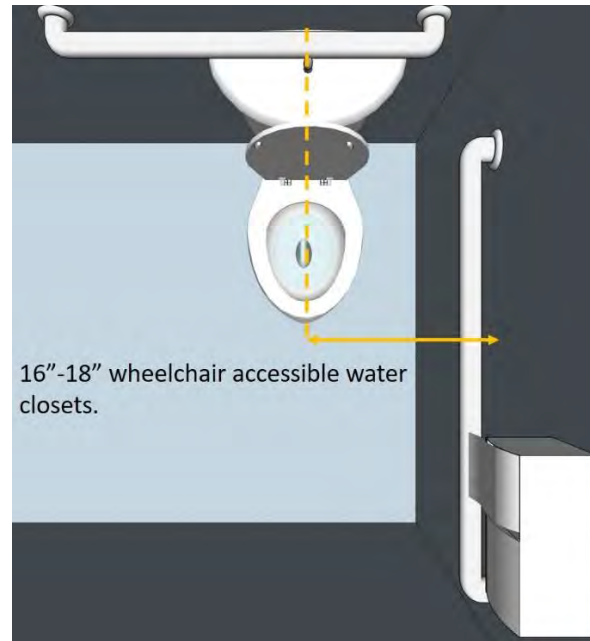

Figure 2.16 Toilet Location

2.9.2 Urinals

Urinals shall comply with §605 of the 2010 ADA Standards for Accessible Design.

Standards:

- Urinals shall be the stall-type or wall-hung
- The rim shall be 17" maximum above the floor and 13 ½" deep minimum measured from the outer face of the urinal rim to the back of the fixture.

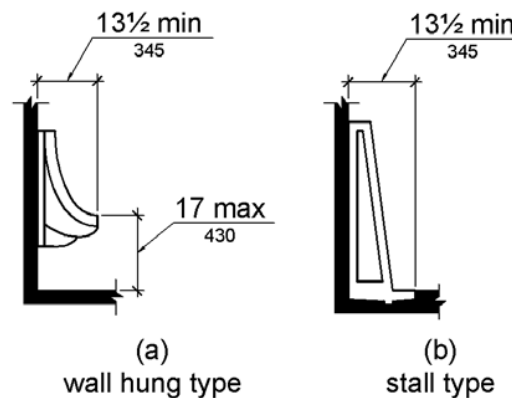

Figure 2.17 Urinal Height and Depth

2.9.3 Toilet Paper Dispenser

Issues with the placement of the toilet paper dispensers, not in compliance with §604.7 of the 2010 ADA Standards for Accessible Design, were extremely common in the Judicial Center, as described below:

Standards:

- Dispensers shall be installed at a height of 7” minimum to 9” maximum in front of the toilet measured to the centerline of the dispenser.
- The outlet shall be within the reach range of 15” minimum and 48” maximum above the floor.
- The toilet paper dispenser shall not be located behind grab bars.
- There shall be a 1 ½” minimum clearance below the grab bar. Dispensers shall not be the type that controls delivery or that does not allow continuous paper flow.

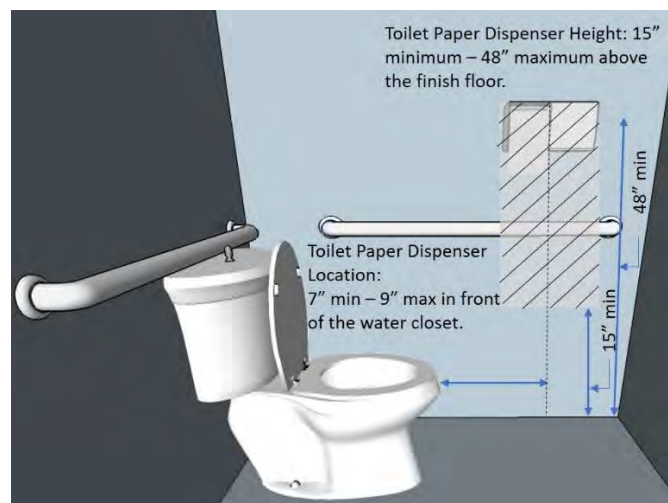

Figure 2.18 Toilet Paper Dispenser

2.9.4 Grab Bars

Grab bars in restrooms must comply with §604.5 of the 2010 ADA Standards for Accessible Design.

Standards:

- Toilet compartment:
 - The top gripping surface of the grab bars must be 33” minimum and 36” maximum above the floor.
 - The sidewall grab bar shall be 42” long minimum, installed at 12” maximum from the back wall.
 - The back-wall grab bar shall be 36” long minimum and extend 12” minimum from the centerline of the toilet on one side and 24” minimum on the other side.
 - ICC/ANSI A117.1, as adopted by the Idaho Statutes Title 39 Chapter 86 [39-8614 (h)], requires a vertical grab bar in each accessible restroom. The vertical grab bar shall be 18” long (minimum). It shall be mounted with the bottom located 39” minimum and 41” maximum above the floor. The centerline of the vertical grab bar shall be located 39” minimum and 41” maximum from the rear wall.

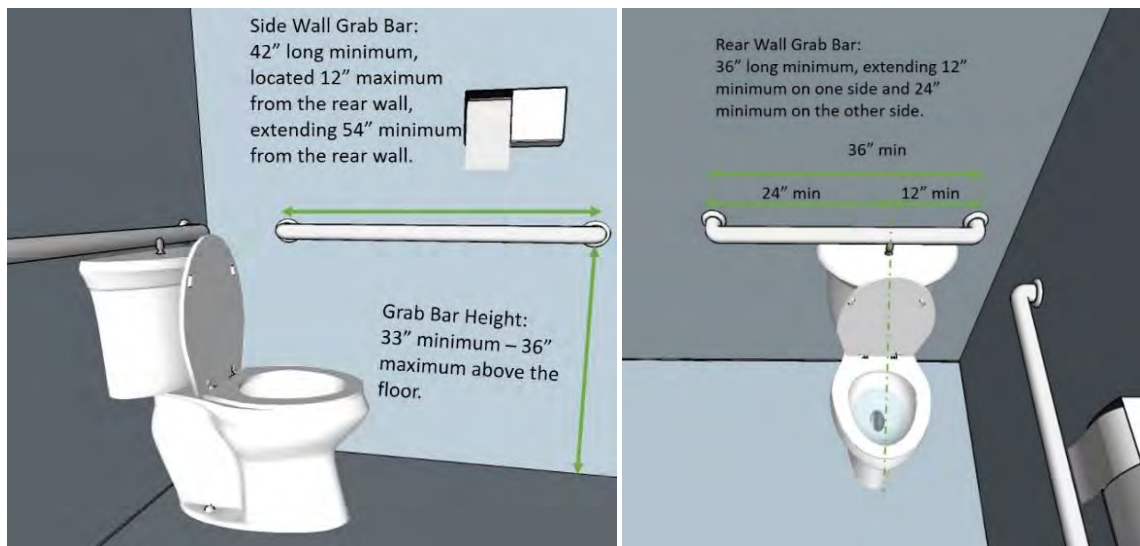

Figure 2.19 Grab Bars

2.9.5 Sink, Mirror, and Shelf

Standards:

- Sinks shall be installed at a maximum height of 34" above the floor.
 - Pipes shall be insulated and configured to prevent contact.
- Mirrors located above sinks shall be installed at a maximum height of 40" above the floor, measured at the bottom of the reflecting surface.
- Coat hooks and shelves shall be located at a minimum reach range of 15" and maximum 48" above the floor.
 - Shelves shall be located 40" minimum and 48" maximum above the floor.

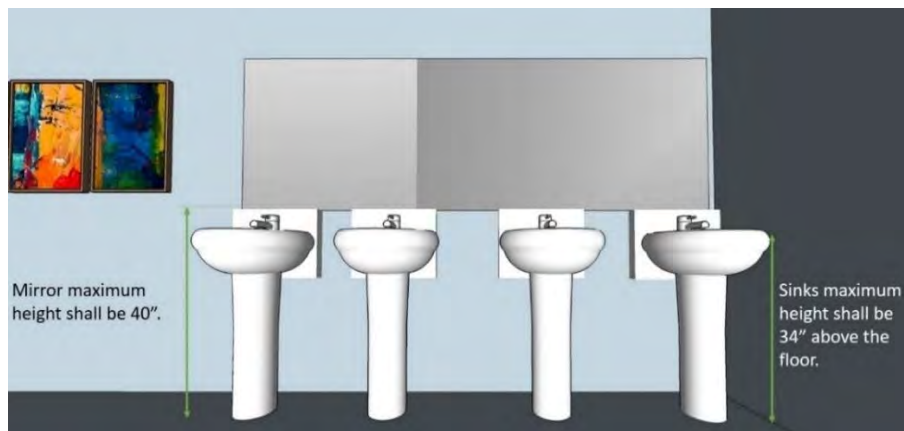

Figure 2.20 Bathroom Sinks and Mirror

2.9.6 Locker Room Showers

Showers in locker rooms must comply with §608 of the 2010 ADA Standards for Accessible Design.

Standards:

- Shower compartments shall have sizes and clearances complying with §608.2.
 - Transfer type shower compartments shall be 36” by 36” clear inside dimensions measured at the center points of opposing sides and shall have a 36” wide minimum entry on the face of the shower compartment.
 - Standard roll-in type shower compartments shall be 30” wide minimum by 60” deep minimum clear inside dimensions measured at center points of opposing sides and shall have a 60” wide minimum entry.
 - Alternate roll-in type shower compartments shall be 36” wide and 60” deep minimum clear inside dimensions measured at center points of opposing sides.
- Shower seats shall be provided in transfer type shower compartments and shall comply with §610.
- Controls, faucets, and shower spray units shall comply with §608.5 and §309.4.

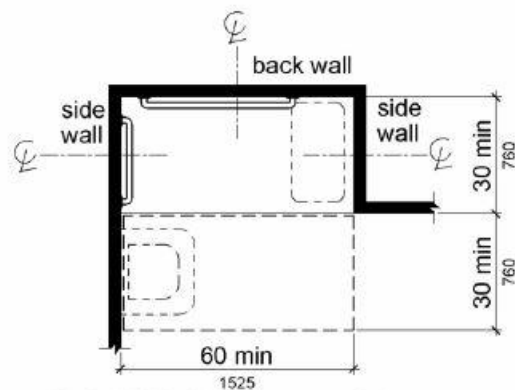

Note: inside finished dimensions measured at the center points of opposing sides

Figure 2.21 Locker Room Showers

2.10 Room Signage

Signs are required to designate permanent rooms and places, per §701 of the 2010 ADA Standards for Accessible Design. In addition, exit doors must be identified by tactile (raised characters and Braille) signs.

Standards:

- Where a tactile sign is provided at a door, the sign shall be located alongside the door at the latch side.
- Signs containing tactile characters shall be located so that a clear floor space of 18” by 18” minimum, centered on the tactile characters, is provided beyond the arc of any door swing.
- Signs shall be installed 48” minimum above the floor, measured from the lowest character, and 60” maximum above the floor measured from the highest character.
- Signage characters and their background shall have a non-glare finish. The characters shall be high contrast compared to their background.

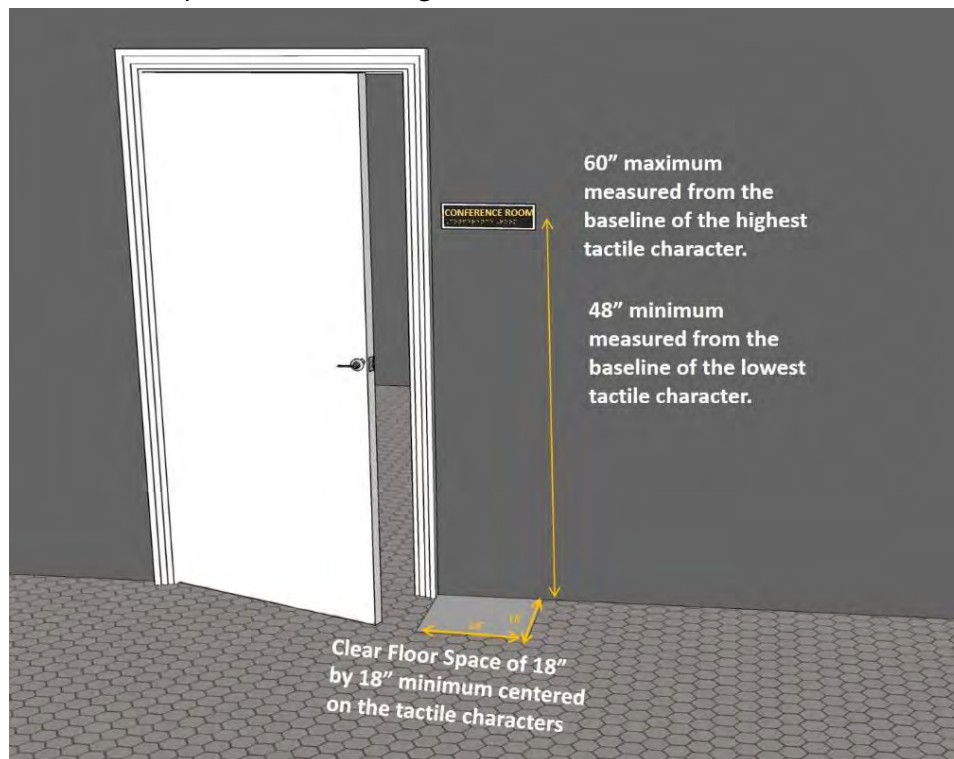

Figure 2.22 Room Signage

3.0 Prioritization

The barriers to accessibility were prioritized on a 10-point scale, as defined in Table 3.1. This prioritization methodology has been developed by Tindale Oliver to assist the City of Boise in determining how the barriers to accessibility can be prioritized based on the severity of the non-compliant item, the existing level of accessibility, and the basic level of accessibility each remediated item will provide.

Priority	Criteria
High	1 <ul style="list-style-type: none"> Major safety issues (dangerously steep slopes, large protruding objects, etc.)
	2 <ul style="list-style-type: none"> New construction built out of compliance Older construction severely out of compliance (accessible routes, ramps, etc.) Alterations that did not bring required elements into compliance
	3 <ul style="list-style-type: none"> Non-compliant accessible route from parking to building entrances (bad slopes, gravel surface, etc.) No accessible route to adjacent sidewalk system, when provided No accessible restroom stalls No accessible parking, insufficient number of spaces, or severely non-compliant parking (bad slopes, gravel surface, extremely narrow, etc.) Severely non-compliant accessible route (structural solution) No tactile signage identifying exits and permanent rooms
	4 <ul style="list-style-type: none"> Non-compliant parking (structural solution) Non-compliant counter heights (break room, multipurpose rooms) No directional signage provided to accessible amenity (interior and exterior) No detectable warnings present at curb ramps
Medium	5 <ul style="list-style-type: none"> Non-compliant exterior or interior door clearances (width issues, protruding objects) Protruding objects obstructing clear pathway (fire extinguishers, AED units) Non-compliant restroom amenities (sink, water closet, urinal, mirror) Non-compliant public access spaces (conference rooms, classrooms)
	6 <ul style="list-style-type: none"> No accessible drinking fountains (missing a high or low fountain) Non-compliant door hardware (doorknob that requires twisting or pinching) Non-compliant showers/changing areas (locker rooms)
	7 <ul style="list-style-type: none"> Non-compliant amenities (picnic tables, benches, vending machines, etc.) Accessible route with moderate access issues (level changes that can be ground down) Non-compliant detectable warnings at curb ramps (high contrast, inadequate length)
Low	8 <ul style="list-style-type: none"> Non-compliant reach ranges (vending machines, garbage cans, AED units) Non-compliant tactile signage at doorways or elevators (height, placement) Accessible seating is not integrated, on a minor sloped area, or inaccessible
	9 <ul style="list-style-type: none"> Non-compliant parking (faded striping, signage)
	10 <ul style="list-style-type: none"> Minor level changes, gaps, or cracks in accessible route Non-compliant drinking fountains

Table 3.1 Prioritization Designations

4.0 Implementation and Financial Plan

In the previous sections, improvements required to bring facilities into full compliance were identified. The next step in the process is the development of an Implementation and Financial Plan for improvements. This was undertaken through the following efforts:

- Preparing cost estimates for the required improvements
- Reviewing the specific improvements in more detail and categorizing them into two separate groups:
 - Short-term (quick fix) improvements
 - Long-term improvements that require more time, effort, and/or funding

4.1 Development of Costs

For the Implementation and Financial Plan, unit costs for each type of improvement were developed. These unit costs were based on local and state data, recent experiences with other agencies and, when available, standard industry costs when local data were not available. **It is important to note that the unit costs include across-the-board assumptions that will need to be reviewed prior to the actual improvement being completed.**

Table 4.1 provides a summary of the total improvement costs, based on their associated priority, as well as the total estimate of probable cost by improvement type.

Note that the costs included in the table are planning-level estimates; once the projects progress through design, the actual construction opinions of cost will become more refined. Also, as the City does not have the funding available to make all these improvements at once, which would offer the most economies of scale, cost estimates are reflective of multiple smaller phases that will be more conducive to the funding available.

It should be noted that the estimates are intended to reflect the order-of-magnitude costs for the City of Boise’s overall facility improvement needs over the timeframe of the plan; for specific projects nearing implementation, it may be necessary for the City to conduct a more detailed cost assessment.

Category	Estimate of Cost
High	\$100,300
Medium	\$110,700
Low	\$300
Total	\$211,300
<i>Quick-Fixes</i>	<i>\$2,300</i>

Table 4.1 Cost Summary

4.2 Implementation Plan

The Implementation and Financial Plan was developed to identify when the improvements should occur based on the relative priority of the improvements and anticipated level of funding that will be available to address them.

It would be ideal if City of Bouse could take advantage of “piggybacking” needed improvements with other planned facility improvement and renovation projects. This would permit the City to benefit either because the project directly addresses some or all of the needed improvements or the project allows the City to reduce its improvement costs due to concurrent construction activities. The amount of implementation costs that could potentially be saved by completing the improvements concurrent with planned projects is not known at this time. Therefore, potential cost savings through fund leveraging are not included in the Implementation and Financial Plan at this time. In the future, should the City desire to estimate the amount of costs that could be reduced through fund leveraging, the cost of the improvements for those impacted improvements may be adjusted.

To develop the initial plan, as listed in Appendix A, the list of improvements was sorted by priority. Quick-fix items were assumed to be completed within the current year. High priority items were generally planned to be completed the following year, followed by Medium and Low priority items.

It should be stressed that the Implementation and Financial Plan serves as a general guide for the planning of improvements and that several factors will influence the timing for implementation of specific improvements and the overall cost of the program, including:

- Opportunities for partnering with other agencies or organizations on implementing improvements.
- Specific site conditions at individual locations, including landscaping, utilities, drainage, which can have a significant impact on the type of improvements required and the associated cost.
- Contracting opportunities, including awarding a unit price contract for the implementation of improvements at multiple locations.
- Additional opportunities to relocate or consolidate individual amenities.

On an annual basis, the City’s ADA Coordinator will supervise the revisions to the ADA Transition Plan and the list of needed improvements will be reviewed against the funding that is available that year to develop a specific work program. As previously mentioned, this will involve development of more detailed cost estimates based on a review of site conditions at individual locations.

Appendix A presents an example of the phased implementation plan by listing the improvements and their proposed priority and associated probable costs. It should be stressed that the costs are good faith estimates of probable cost, with the ultimate costs dependent upon how the work is undertaken, site conditions at individual locations, and material and labor prices in future years. The number of items that are consolidated, modified, relocated, or removed will also be an important variable, as will be the amount of work that will be the responsibility of other entities.

Due to the unknown level of funding currently available for accessibility improvements, current renovation schedule, and the completion of the quick-fix improvement list, the items recommended for improvement for each year of the program are not necessarily the highest-ranking items on the priority list. However, as the improvement program progresses, high-ranking items that were not initially improved should be included in future years.

It should be noted that the prioritization rankings/implementation plan is just a guide. The number of items improved each year and the specific locations chosen for improvement may vary due to factors such as actual costs of the improvement. As such, the improvements will need to be reviewed and a work program developed specifying the improvements that will be undertaken on an annual basis. The improvements would be undertaken through task orders. It is envisioned that the effort could focus on implementation of improvements within specific sections of the building or would occur with groups of similar improvements throughout the City, both of which could enable improvements to be implemented more quickly.

It should be stressed that this plan is presented as an overall guide to the implementation of improvements. City staff will need to review the needed improvements and the available funding on an annual basis to develop the annual improvement program.

City of Boise
ADA Assessment



Appendix A – Lowell Pool

11/20/2020

Report #TO20-B004

Prepared by:





ID:
3775

Facility:
Lowell Pool

Priority Score 3



Quick Fix: Yes

Built before ADA: Yes

Location: Mechanical Rooms

Schedule: 2021

Estimated Cost: \$200.00

VIOLATIONS

2010 ADA Standards for Accessible Design Codes: §216.2, §703

There is no tactile sign identifying the permanent room.

RECOMMENDATIONS

Install tactile signage on the latch side of the doorway at a height of 48" minimum to 60" maximum above the floor, identifying room by name or room number.

Signs shall be Braille with raised lettering and should be placed on the wall in the center of an 18"x18" clear floor space.

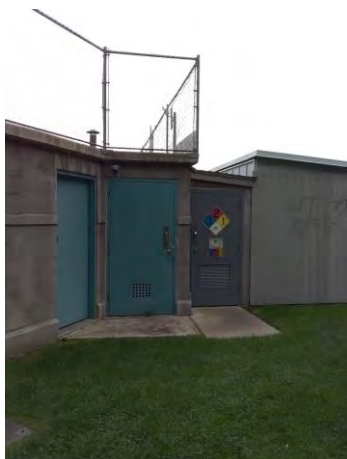
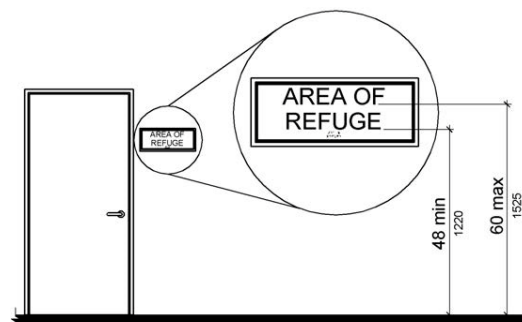



ID:
3283

Facility:
Lowell Pool

Priority Score 3



Quick Fix: No

Built before ADA: Yes

Location: Men and Women's Locker Room

Schedule: 2022

Estimated Cost: \$4,000.00

VIOLATIONS

2010 ADA Standards for Accessible Design Codes: §505.4, §505.10.2

Handrails are provided only on one side, and there are no handrail extensions at the top of the stairs. The stair handrails are located 30" and 31" above the stair nosings. Both violations are located outside the men and women's locker rooms.

RECOMMENDATIONS

Install new handrails on both sides of the stairs with extensions that extend at least 12" horizontally above the landing beginning directly above the first stair riser nosing.

Ensure that handrails are installed at a minimum height of 34" and a maximum of 38" above the stair nosings. The height shall be consistent along the stair treads.





ID:
4462

Facility:
Lowell Pool

Priority Score 3



Quick Fix: No

Built before ADA: Yes

Location: Men and Women's Locker Room

Schedule: 2022

Estimated Cost: \$50,000.00

VIOLATIONS

2010 ADA Standards for Accessible Design Codes: §407

The stairs are not accessible for persons in wheelchair.

RECOMMENDATIONS

Construct a 60"x60" elevator with a 36" wide door connecting the pool deck to the proposed accessible locker rooms. Controls shall be installed at 48" maximum above the floor and emergency controls at 38" above the floor. Ensure car position indicators provide verbal announcements of stops. Floor designations shall be provided on both hoistway door jambs and a tactile star shall be provided on the main entry

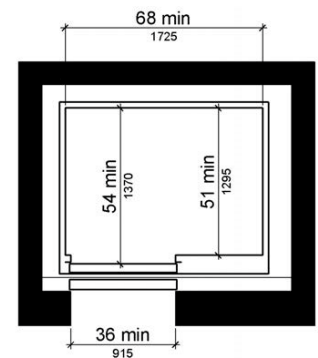

(b)
side (off-centered) door

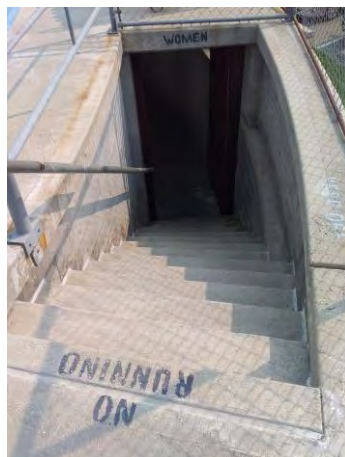



ID:
3048

Facility:
Lowell Pool

Priority Score 6



Quick Fix: No

Built before ADA: Yes

Location: Men and Women's Locker Room

Schedule: 2022

Estimated Cost: \$80,000.00

VIOLATIONS

2010 ADA Standards for Accessible Design Codes: §308, §604, §608

There is not an accessible shower or stall provided in the men and women's locker room. The shower dimensions do not meet the requirements for a transfer type shower at 43"x31". The stalls provided are too small to be accessible.

RECOMMENDATIONS

Due to the historic nature and limited space of the facility, consider constructing an adjacent facility containing an accessible locker rooms, showers, and restroom stalls.

Elements in the accessible shall comply with Section 2.9 of the Lowell Report.

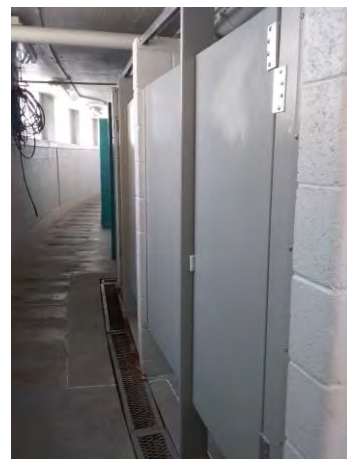



ID:
3609

Facility:
Lowell Pool

Priority Score 3



Quick Fix: No

Built before ADA: Yes

Location: Men and Women's Locker Rooms

Schedule: 2021

Estimated Cost: \$3,000.00

VIOLATIONS

2010 ADA Standards for Accessible Design Codes: §302.3

The grates in the men and women's locker room path are not stable.

RECOMMENDATIONS

Replace the grates throughout the locker rooms and ensure that they are secure and stable. Ensure that the openings in the grate is less than 0.5”.

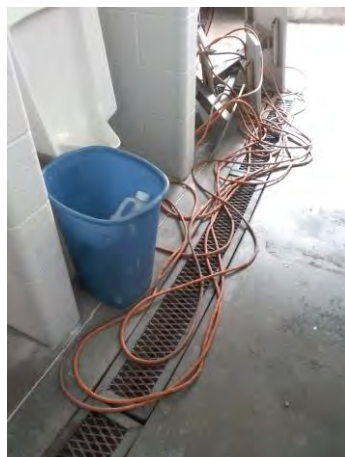
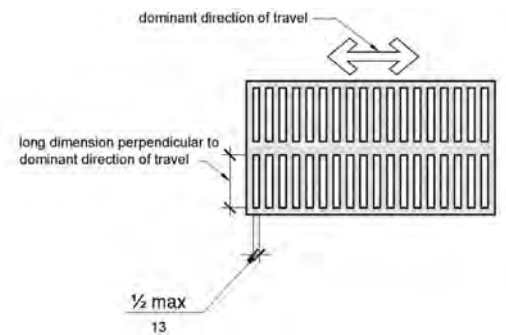



ID:
3412

Facility:
Lowell Pool

Priority Score 3



Quick Fix: Yes

Built before ADA: Yes

Location: Men's Locker Room

Schedule: 2021

Estimated Cost: \$100.00

VIOLATIONS

2010 ADA Standards for Accessible Design Codes: §216.2, §703

There is no tactile sign identifying the permanent room.

RECOMMENDATIONS

Install tactile signage on the latch side of the doorway at a height of 48" minimum to 60" maximum above the floor, identifying room by name or room number.

Signs shall be Braille with raised lettering and should be placed on the wall in the center of an 18"x18" clear floor space.

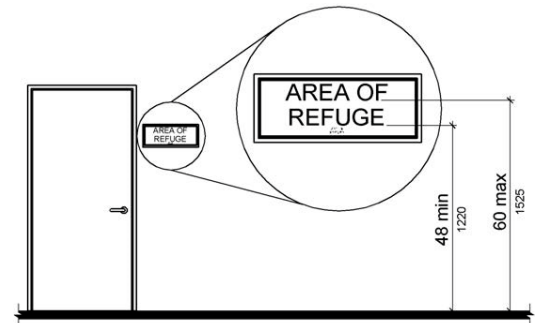



ID:
3254

Facility:
Lowell Pool

Priority Score 5



Quick Fix: Yes

Built before ADA: Yes

Location: Men's Locker Room

Schedule: 2022

Estimated Cost: \$200.00

VIOLATIONS

2010 ADA Standards for Accessible Design Codes: §307.2

The hose protrudes 6" into the circulation space at 63" above the floor.
The air conditioning unit protrudes 7" into the circulation space at 78" above the floor.

RECOMMENDATIONS

Recess the hose and air conditioning unit so they protrude a maximum of 4", lower them so the bottom edge is 27" maximum above the floor, or place a cane detectable object beneath it.

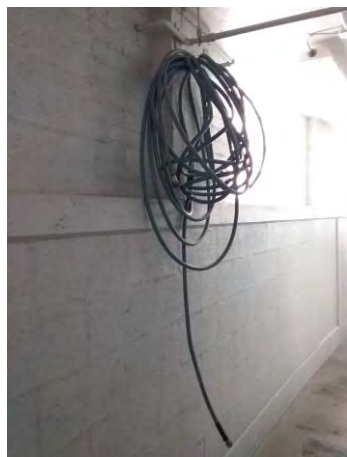
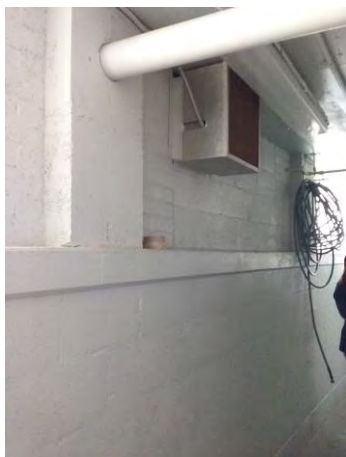
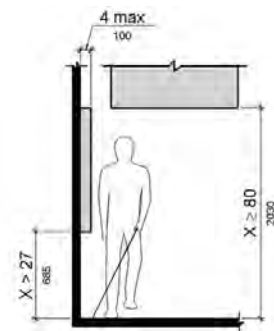



ID:
3307

Facility:
Lowell Pool

Priority Score 7



Quick Fix: Yes

Built before ADA: Yes

Location: Men's Locker Room

Schedule: 2022

Estimated Cost: \$200.00

VIOLATIONS

2010 ADA Standards for Accessible Design Codes: §606.5

The pipes under the sink are not covered.

RECOMMENDATIONS

Wrap the pipes beneath the sink with soft protective wrap or plastic.

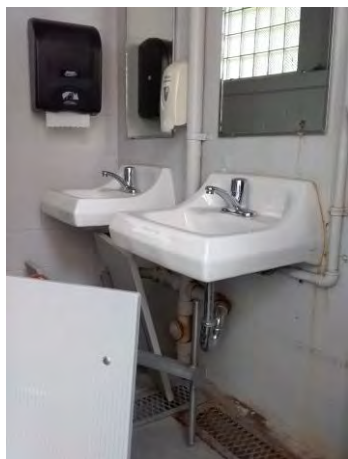



ID:
3186

Facility:
Lowell Pool

Priority Score 5



Quick Fix: No

Built before ADA: Yes

Location: Men's Locker Room

Schedule: 2022

Estimated Cost: \$1,000.00

VIOLATIONS

2010 ADA Standards for Accessible Design Codes: §903.3

The benches in the men's locker room are 14" deep.

RECOMMENDATIONS

Install a new accessible bench that is at least 42" long and 20" minimum to 24" maximum deep.





ID:
3341

Facility:
Lowell Pool

Priority Score 6



Quick Fix: No

Built before ADA: Yes

Location: Men's Locker Room

Schedule: 2022

Estimated Cost: \$1,000.00

VIOLATIONS

2010 ADA Standards for Accessible Design Codes: §211.2, §307.2, §602.7

There is only one drinking fountain in the men's locker room provided at 33" above the floor. The drinking fountain protrudes 16" into the circulation path.

RECOMMENDATIONS

Install an additional drinking fountain at a minimum height of 38" and maximum of 43" above the floor.

Place a drinking fountain skirt at this location to provide cane detectability.





ID:
3472

Facility:
Lowell Pool

Priority Score 3



Quick Fix: No

Built before ADA: Yes

Location: Men's Locker Room

Schedule: 2021

Estimated Cost: \$2,000.00

VIOLATIONS

2010 ADA Standards for Accessible Design Codes: §304.3.1

There is not an adequate turning space in the men's locker room.

RECOMMENDATIONS

Expand the space to provide a Circular or T-Shaped turning space. The circular turning space shall have a minimum diameter of 60".

The T-Shaped space shall be 60" square minimum with arms and base 36" wide minimum. Each arm shall be clear of obstructions 12" minimum in each direction. The base shall be clear of obstruction 24" minimum.

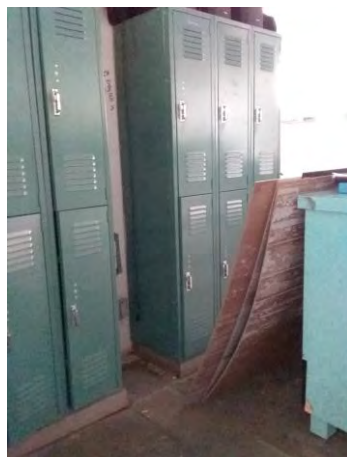



ID:
3242

Facility:
Lowell Pool

Priority Score 9



Quick Fix: Yes

Built before ADA: Yes

Location: Parking Lot

Schedule: 2023

Estimated Cost: \$100.00

VIOLATIONS

2010 ADA Standards for Accessible Design Codes: §502.6

The accessible parking sign is 46" above the floor.

RECOMMENDATIONS

Remount the accessible parking sign at a minimum height of 60" above the ground.

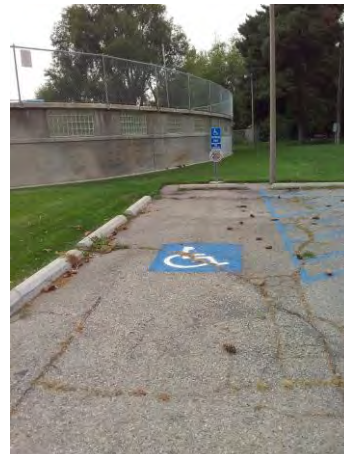
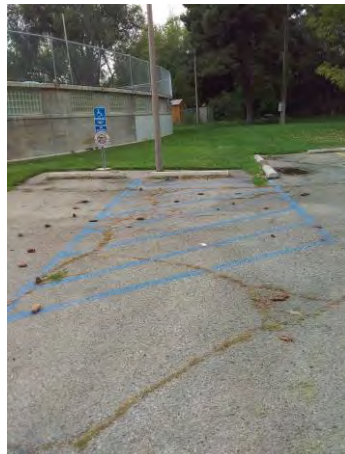
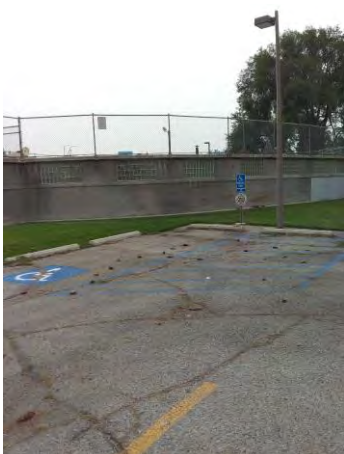



ID:
3636

Facility:
Lowell Pool

Priority Score 6



Quick Fix: Yes

Built before ADA: Yes

Location: Parking Lot

Schedule: 2022

Estimated Cost: \$100.00

VIOLATIONS

2010 ADA Standards for Accessible Design Codes: §302.1, §305

There is not a firm, stable, and slip resistant route to the garbage can. There is no clear floor space to access the garbage can.

RECOMMENDATIONS

Relocate the garbage to be adjacent to the accessible route or another firm, stable, and slip resistant surface with clear floor space of 30"x48". Ensure that the clear floor space has a maximum slope of 2% in all directions.





ID:
3243

Facility:
Lowell Pool

Priority Score 5



Quick Fix: No

Built before ADA: Yes

Location: Parking Lot

Schedule: 2022

Estimated Cost: \$2,000.00

VIOLATIONS

2010 ADA Standards for Accessible Design Codes: §303.2

There is a change in level greater than 0.25" in the accessible parking space and access aisle creating tripping hazards.

RECOMMENDATIONS

Resurface the parking spaces and access aisle to reduce the changes in level to less than 0.25".

Ensure that there is a maximum slope of 2% in all directions.

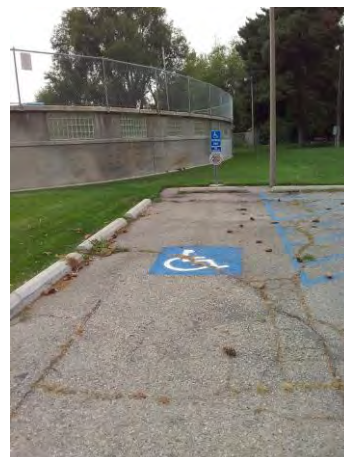
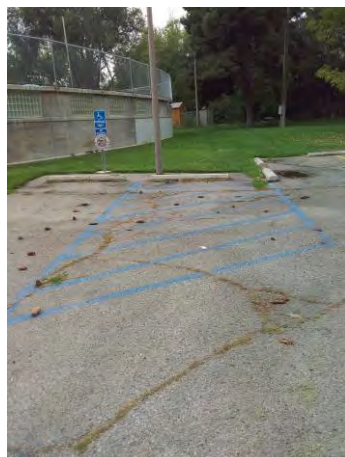
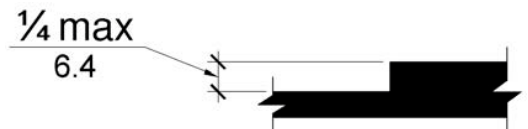



ID:
3426

Facility:
Lowell Pool

Priority Score 6



Quick Fix: No

Built before ADA: Yes

Location: Picnic Tables

Schedule: 2022

Estimated Cost: \$5,000.00

VIOLATIONS

2010 ADA Standards for Accessible Design Codes: §302.1, §305, §902.4

The picnic tables are not compliant because there is no wheelchair seating available. There is not a firm, stable, and slip resistant route to the picnic tables.

RECOMMENDATIONS

Install a new accessible picnic table at a minimum height of 28" and maximum of 34". Provide knee clearance that is a minimum of 11" deep at 9" above the floor and 8" deep at 27" above the floor.

Construct a firm, stable, and slip resistant accessible route with a maximum cross slope of 2% and maximum running slope of 5%.





ID:
3336

Facility:
Lowell Pool

Priority Score 1



Quick Fix: No

Built before ADA: Yes

Location: Pool Deck

Schedule: 2021

Estimated Cost: \$20,000.00

VIOLATIONS

2010 ADA Standards for Accessible Design Codes: §242.2, §1009

The pool has a circumference of approximately 250 linear feet with no accessible means of entry from the deck into the water.

RECOMMENDATIONS

Install a pool lift complying with §1009. Ensure that adjacent to the lift is a 30"x48" clear floor space with a maximum slope of 2% in all directions.

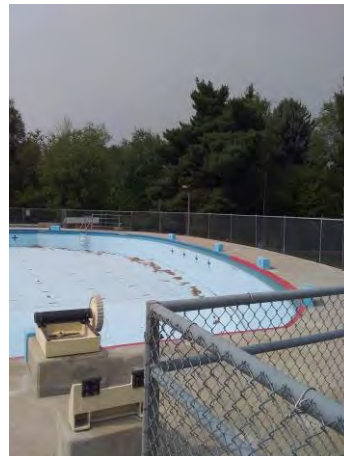



ID:
3089

Facility:
Lowell Pool

Priority Score 8



Quick Fix: Yes

Built before ADA: Yes

Location: Pool Entrance Check-In Area

Schedule: 2023

Estimated Cost: \$100.00

VIOLATIONS

2010 ADA Standards for Accessible Design Codes: §308.2.1

The microwave is outside of the unobstructed forward reach range at 49" above the floor.

RECOMMENDATIONS

Lower the microwave by 1" to meet the accessible reach range of 15" minimum and 48" maximum above the floor.

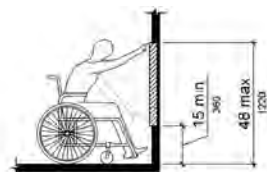



ID:
3090

Facility:
Lowell Pool

Priority Score 8



Quick Fix: Yes

Built before ADA: Yes

Location: Pool Entrance Check-In Area

Schedule: 2023

Estimated Cost: \$100.00

VIOLATIONS

2010 ADA Standards for Accessible Design Codes: §308.2.1

The toaster is outside of the unobstructed forward reach range at 58" above the floor.

RECOMMENDATIONS

Lower the toaster by 10" to meet the accessible reach range of 15" minimum and 48" maximum above the floor.

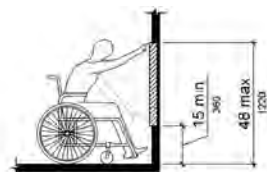



ID:
3088

Facility:
Lowell Pool

Priority Score 5



Quick Fix: Yes

Built before ADA: Yes

Location: Pool Entrance Check-In Area

Schedule: 2022

Estimated Cost: \$100.00

VIOLATIONS

2010 ADA Standards for Accessible Design Codes: §307.2

The shelf protrudes 15" into the circulation space at 43" above the floor.

RECOMMENDATIONS

Place a cane detectable object on either edge of the shelf.

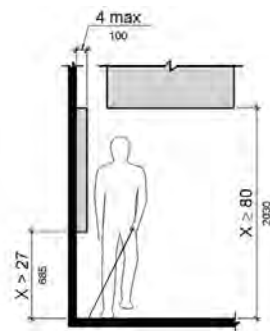



ID:
3290

Facility:
Lowell Pool

Priority Score 5



Quick Fix: Yes

Built before ADA: Yes

Location: Pool Entrance Check-In Area

Schedule: 2022

Estimated Cost: \$100.00

VIOLATIONS

2010 ADA Standards for Accessible Design Codes: §307.2

The paper towel dispenser protrudes 8" into the circulation space at 44" above the floor.

RECOMMENDATIONS

Recess the paper towel dispenser so it protrudes a maximum of 4", lower it so the bottom edge is 27" maximum above the floor, or place a cane detectable object beneath it.

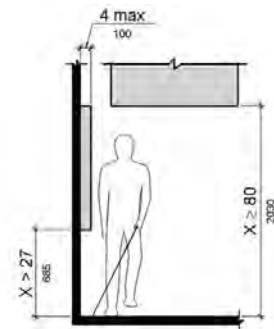



ID:
3352

Facility:
Lowell Pool

Priority Score 4



Quick Fix: No

Built before ADA: Yes

Location: Pool Entrance Check-In Area

Schedule: 2021

Estimated Cost: \$1,000.00

VIOLATIONS

2010 ADA Standards for Accessible Design Codes: §904.4.1

The counter in the pool entrance check-in area is 42" above the floor.

RECOMMENDATIONS

Lower a section of the counter by at least 6" to meet the required maximum height of 36" above the finish floor for a horizontal distance of 36".





ID: 3753

Facility: Lowell Pool

Priority Score 3



Quick Fix: No

Built before ADA: Yes

Location: Pool Entrance Check-In Area

Schedule: 2021

Estimated Cost: \$10,000.00

VIOLATIONS

2010 ADA Standards for Accessible Design Codes: §304.3.1

There is not an adequate turning space in the check-in area.

RECOMMENDATIONS

Expand the space to provide a Circular or T-shaped turning space. The circular turning space shall have a minimum diameter of 60".

The T-Shaped space shall be 60" square minimum with arms and base 36" wide minimum. Each arm shall be clear of obstructions 12" minimum in each direction. The base shall be clear of obstruction 24" minimum.

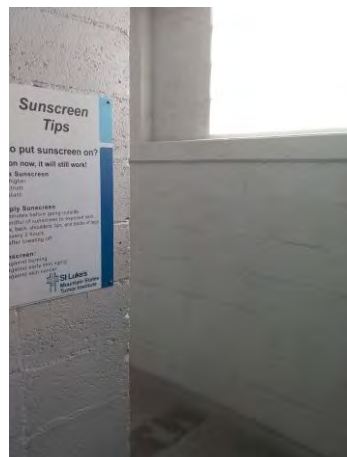
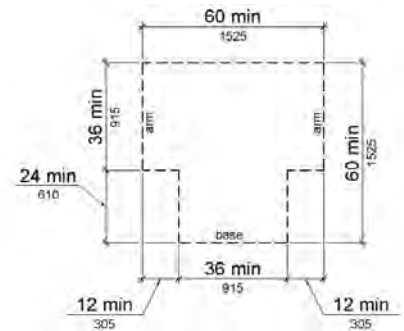



ID:
3112

Facility:
Lowell Pool

Priority Score 3



Quick Fix: No

Built before ADA: Yes

Location: Route from Parking to the Entrance

Schedule: 2021

Estimated Cost: \$5,000.00

VIOLATIONS

2010 ADA Standards for Accessible Design Codes: §403.3

The running slope of the route connecting the accessible parking space to the entrance reaches 15%.

RECOMMENDATIONS

Resurface the route to reduce the running slope to a maximum of 5%. Ensure that the cross slope is a maximum of 2%.

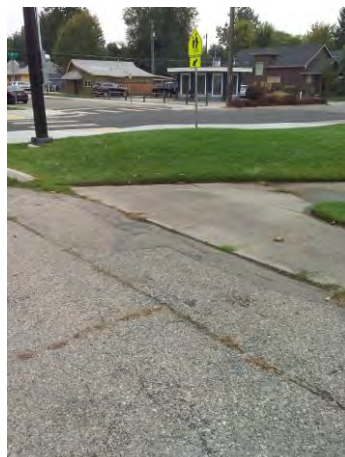



ID:
3374

Facility:
Lowell Pool

Priority Score 5



Quick Fix: Yes

Built before ADA: Yes

Location: Women's Locker Room

Schedule: 2022

Estimated Cost: \$100.00

VIOLATIONS

2010 ADA Standards for Accessible Design Codes: §307.2

The paper towel dispenser protrudes 8" into the circulation space at 48" above the floor.

RECOMMENDATIONS

Recess the paper towel dispenser so it protrudes a maximum of 4", lower it so the bottom edge is 27" maximum above the floor, or place a cane detectable object beneath it.

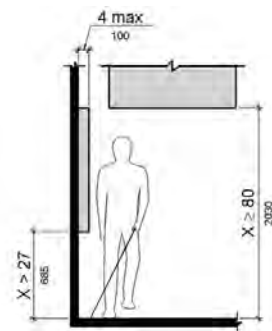



ID:
3255

Facility:
Lowell Pool

Priority Score 5



Quick Fix: Yes

Built before ADA: Yes

Location: Women's Locker Room

Schedule: 2022

Estimated Cost: \$200.00

VIOLATIONS

2010 ADA Standards for Accessible Design Codes: §307.2, §308.2.1

The hose and hooks holding them are outside of the unobstructed forward reach range at 50" above the floor and protrude into the circulation space.

RECOMMENDATIONS

Lower the hooks by 2" to meet the accessible reach range of 15" minimum and 48" maximum above the floor.

Recess the hose to protrude a maximum of 4", lower it so the bottom edge is 27" maximum above the floor, or place a cane detectable object beneath it.





ID:
3480

Facility:
Lowell Pool

Priority Score 7



Location: Women's Locker Room

Schedule: 2022

Estimated Cost: \$200.00

Quick Fix: Yes

Built before ADA: Yes

VIOLATIONS

2010 ADA Standards for Accessible Design Codes: §606.5

The pipes under the sinks are not covered.

RECOMMENDATIONS

Wrap the pipes beneath the sinks with soft protective wrap or plastic.

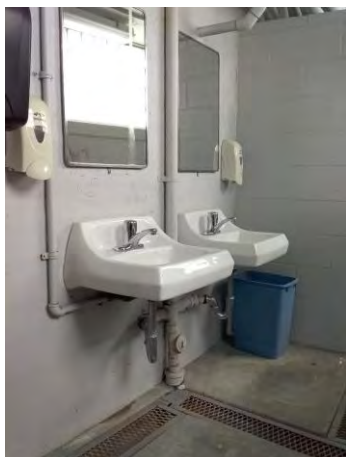



ID:
3299

Facility:
Lowell Pool

Priority Score 5



Quick Fix: Yes

Built before ADA: Yes

Location: Women's Locker Room

Schedule: 2022

Estimated Cost: \$500.00

VIOLATIONS

2010 ADA Standards for Accessible Design Codes: §307.2

The electrical box in the women's locker room protrudes 7" into the circulation space at 78" above the floor.

RECOMMENDATIONS

Recess the electrical box so it protrudes a maximum of 4", or place a cane detectable object beneath it.

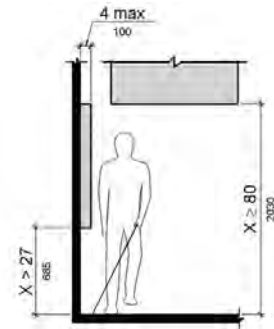



ID:
3606

Facility:
Lowell Pool

Priority Score 3



Quick Fix: No

Built before ADA: Yes

Location: Women's Locker Room

Schedule: 2021

Estimated Cost: \$5,000.00

VIOLATIONS

2010 ADA Standards for Accessible Design Codes: §403.3

The cross slope is 2.3% throughout the Women's Locker Room.

RECOMMENDATIONS

Resurface the route to reduce the cross slope to a maximum of 2%.

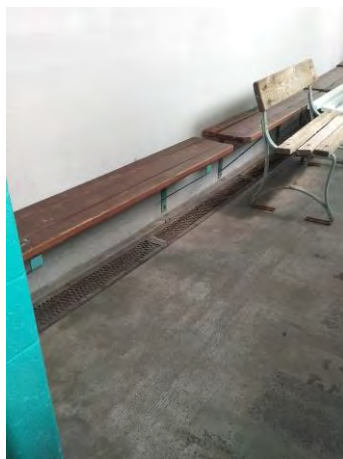
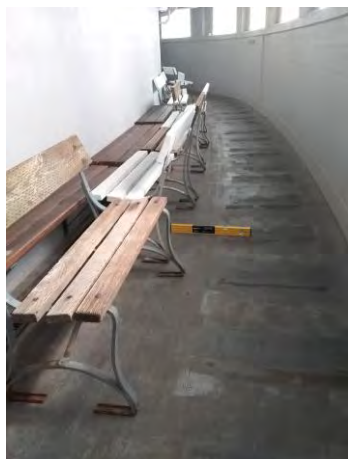
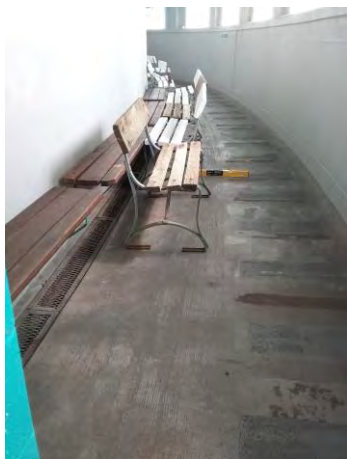



ID:
3465

Facility:
Lowell Pool

Priority Score 6



Quick Fix: No

Built before ADA: Yes

Location: Women's Locker Room

Schedule: 2022

Estimated Cost: \$20,000.00

VIOLATIONS

2010 ADA Standards for Accessible Design Codes: §213.3.1, §604

There is not an accessible stall in the women's locker room.

RECOMMENDATIONS

Due to space constraints, construct an accessible exterior restroom as suggested in Section 2.9 of the Lowell Report at least 60" deep and 35" to 37" wide.

